

# ACHTERGEVEL

LINKER ZIJGEVEL  
4578  
4200

RECHTER ZIJGEVEL  
2386  
1700

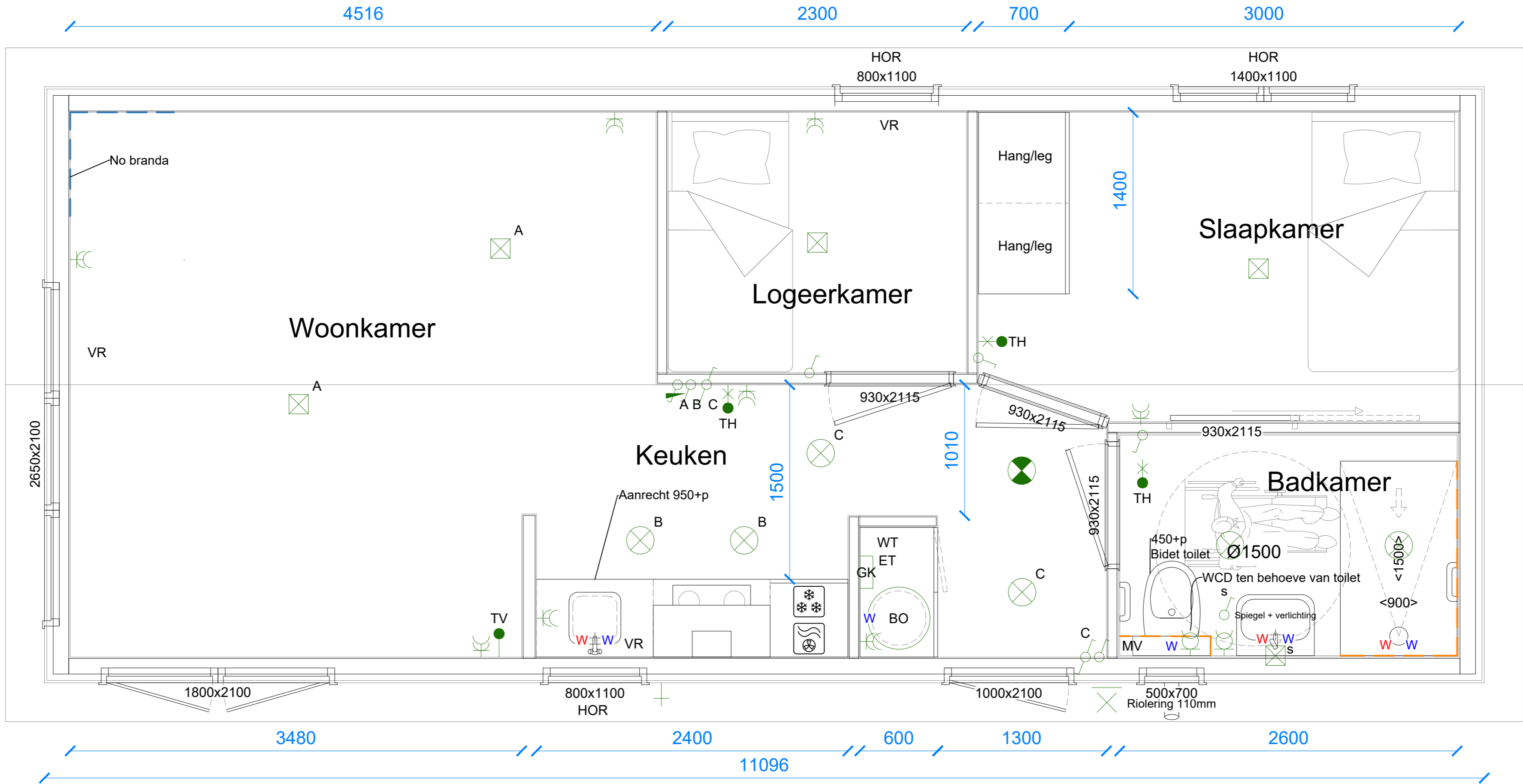

# VOORGEVEL

Projectnaam: Sessink	Projectnummer: 4573	Type: Anemoon	Datum tekening: 07/07/2021	Formaat: ISO full bleed A2 (594.00 x 420.00 MM)	Schaal: 1:25
-------------------------	------------------------	------------------	-------------------------------	---	-----------------

Renvooi:

	Enkeelpolige schakelaar		buitenkraan		Rookmelder		Lichtpunt		Geaard waterdicht stopcontact		Elektra tussenmeter		Aansluiting bedraad tv		Elektrische boiler
	Enkeelpolig dimbare schakelaar		Wisselschakelaar		Binnenspot		Buitenlamp aansluiting		Dubbel geaard stopcontact		Water tussenmeter		Aansluiting bedraad thermostaat		Groepenkast
											Horren		Mechanische ventilatie		Ventilatie rooster

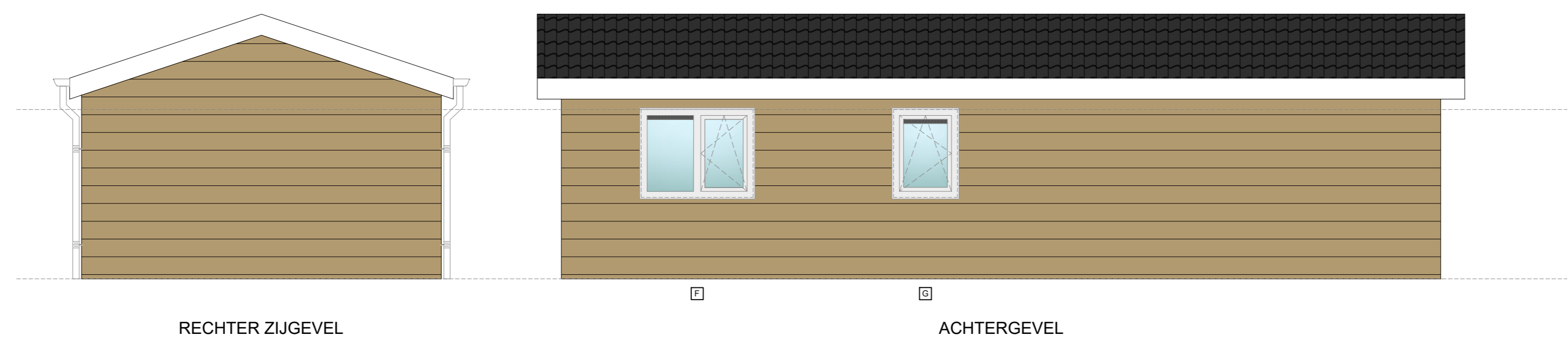

Projectnaam: Sessink	Projectnummer: 4573	Type: Anemoon	Datum tekening: 07/07/2021	Formaat: ISO full bleed A2 (594.00 x 420.00 MM)	Schaal: 1:50
-------------------------	------------------------	------------------	-------------------------------	---	-----------------

Bovenkant dagmaat kozijn standaard 2120+P

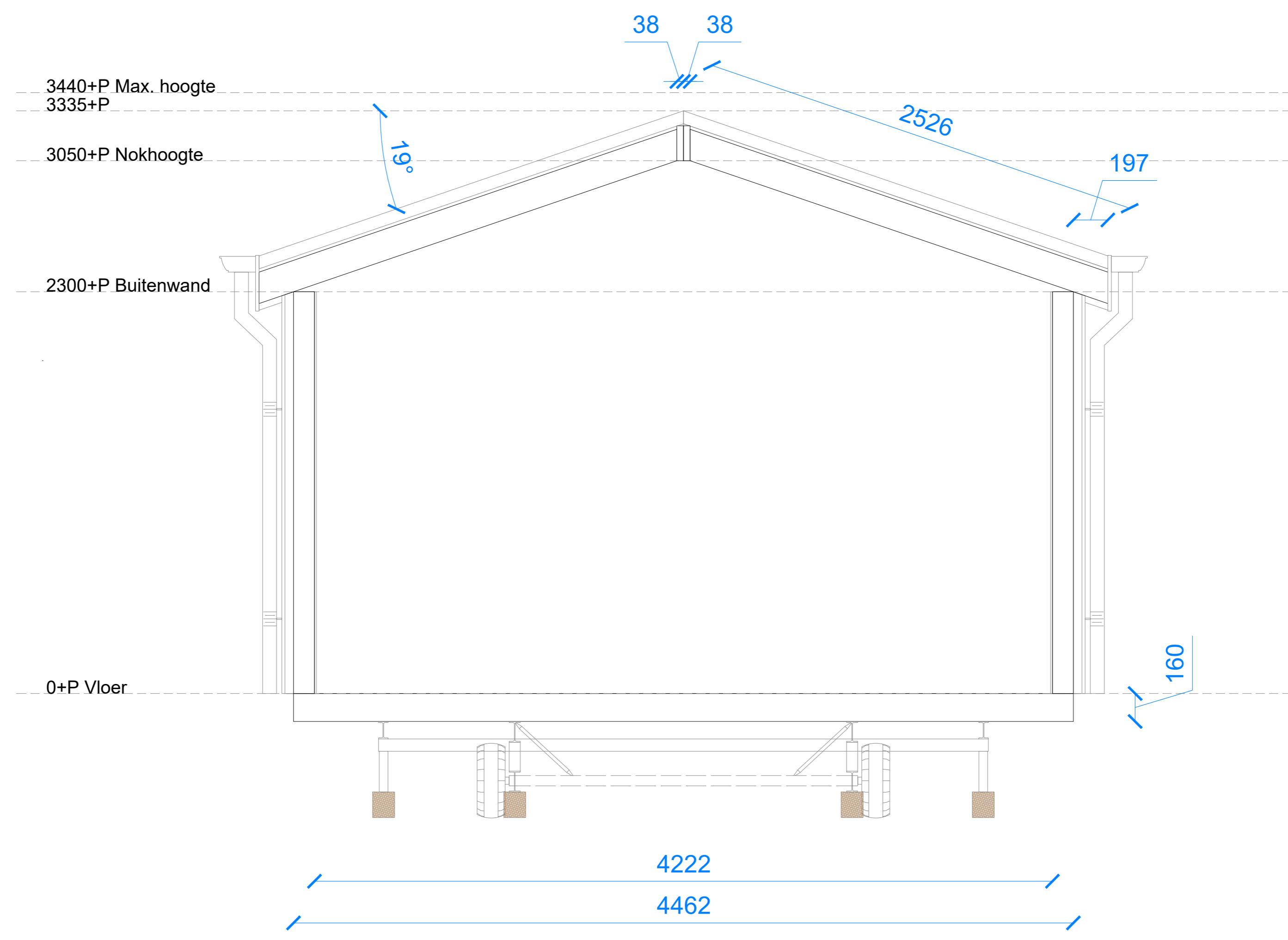

Projectnaam: Sessink	Projectnummer: 4573	Type: Anemoon	Datum tekening: 07/07/2021	Formaat: ISO full bleed A2 (594.00 x 420.00 MM)	Schaal: 1:20
-------------------------	------------------------	------------------	-------------------------------	---	-----------------

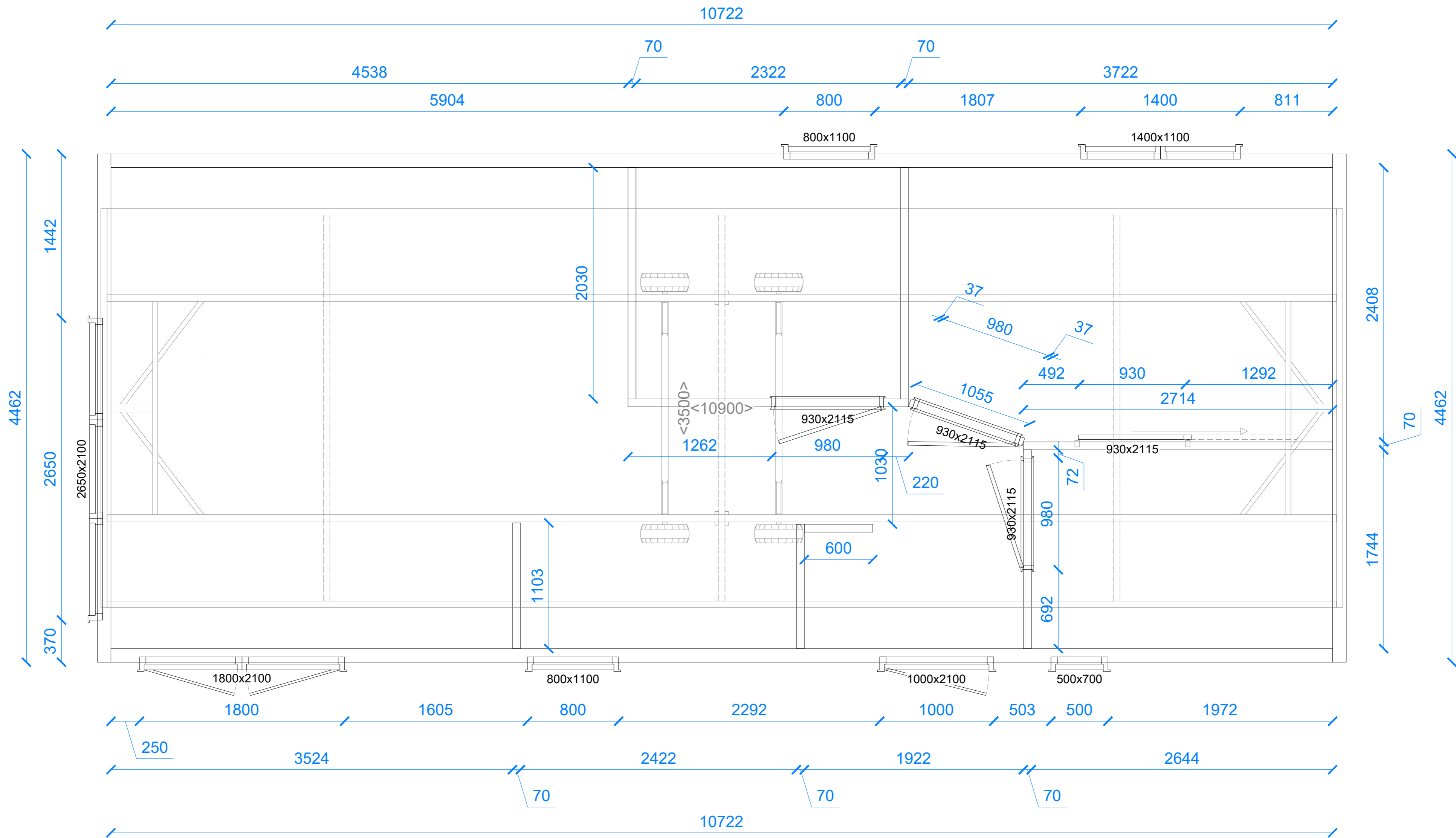

Projectnaam:	Projectnummer:	Type:	Datum tekening:	Formaat:	Schaal:
Sessink	4573	Anemoon	07/07/2021	ISO full bleed A2 (594.00 x 420.00 MM)	1:25

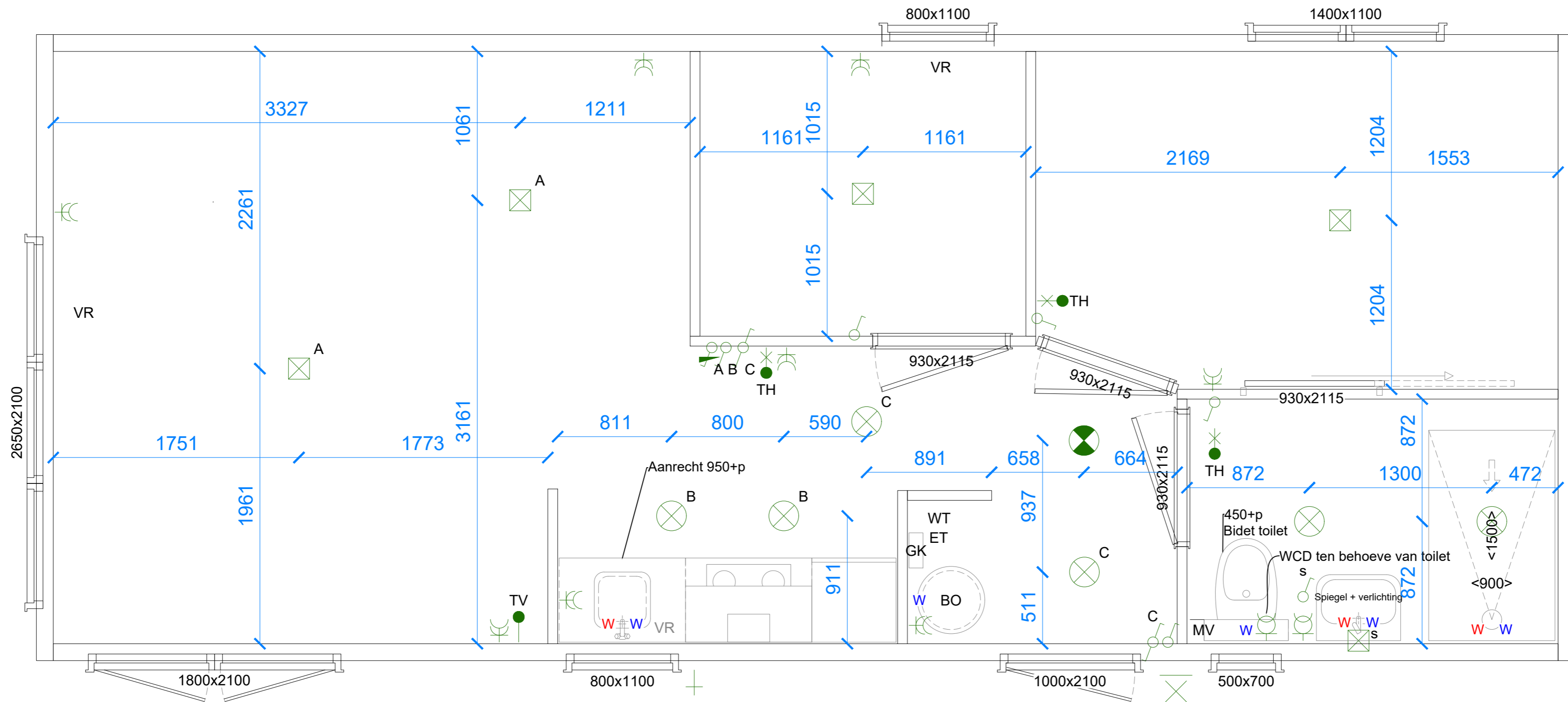

■ Projectnaam:	■ Projectnummer:	■ Type:
Sessink	4573	Anemoon

■ Datum tekening:	■ Formaat:	■ Schaal:
07/07/2021	ISO full bleed A2 (594.00 x 420.00 MM)	1:25

■ Datum tekening:	■ Formaat:	■ Schaal:
07/07/2021	ISO full bleed A2 (594.00 x 420.00 MM)	1:25

Standaard hoogtes tenzij anders aangegeven:		P = Vloerplaat
Wandcontactdozen 700 mm + vloerpeil		WCD 300 mm uit de hoek
TV aansluiting 700 mm + vloerpeil		
Schakelaars 1000 mm + vloerpeil		
Thermostaat 1500 mm + vloerpeil		

Renivooi:

⚡	Enkeelpolige schakelaar
⚡	Enkeelpolig dimbare schakelaar

+	buitenkraan
⚡	Wisselschakelaar

⊗	Rookmelder
⊗	Binnenspot

⊗	Lichtpunt
⊗	Buitenspots aansluiting

⊗	Geaard waterdicht stopcontact
⊗	Dubbel geaard stopcontact

ET	Elektra tussenmeter
WT	Water tussenmeter
HOR	Herren

TV	Aansluiting bedraad tv
TH	Aansluiting bedraad thermostaat
MV	Mechanische ventilatie

EB	Elektrische boiler
GK	Groepenkast
VR	Ventilatie rooster

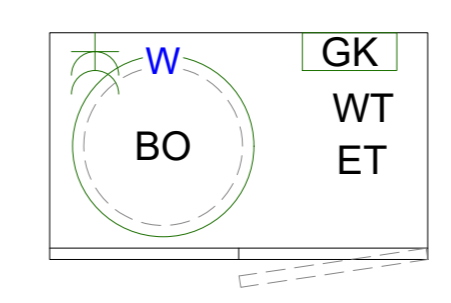
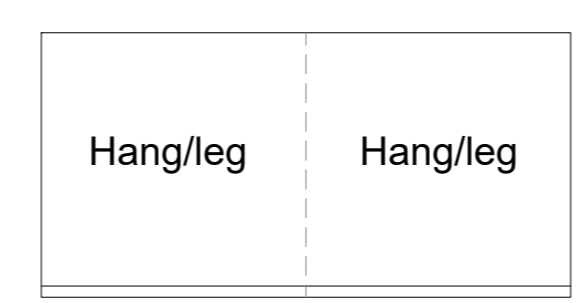
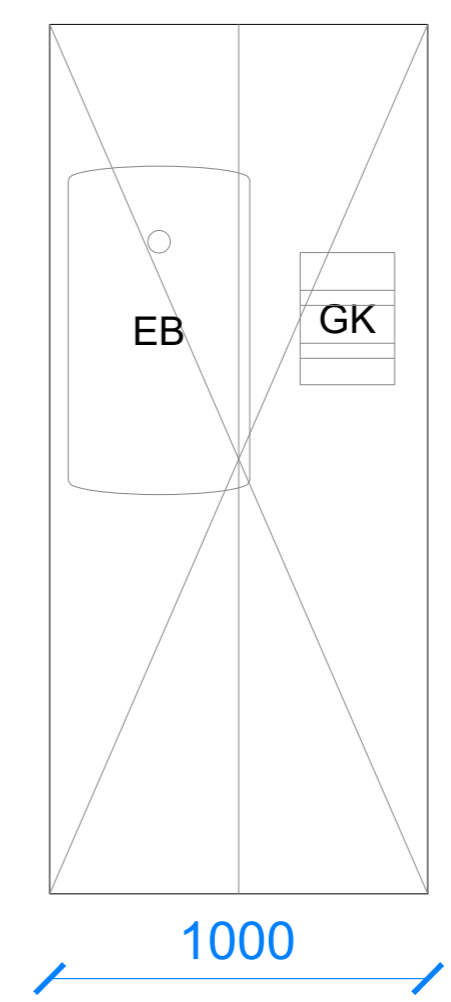
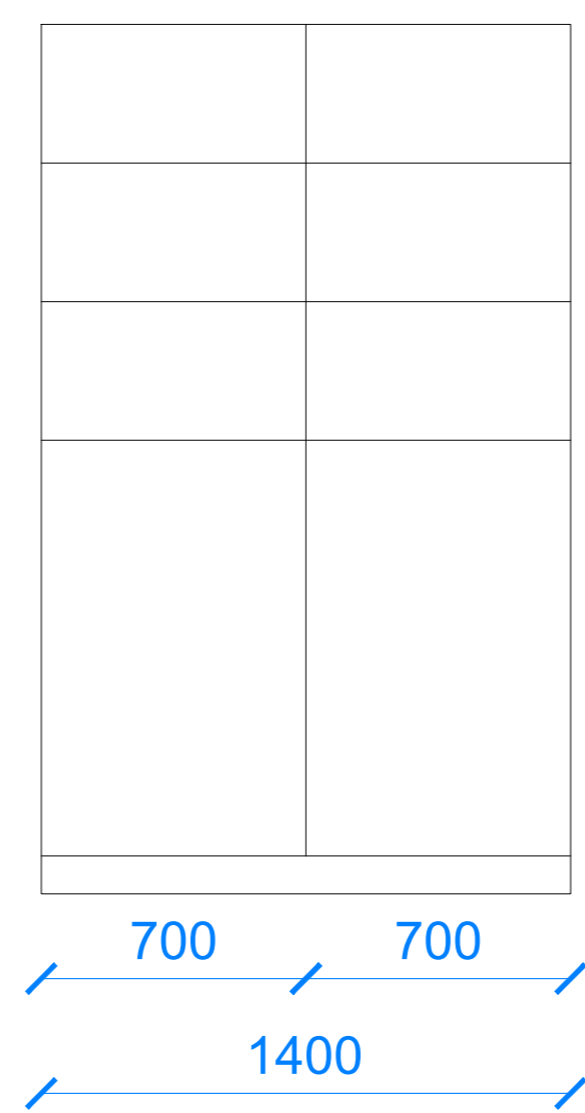

■ Projectnaam: Sessink	■ Projectnummer: 4573	■ Type: Anemoon	■ Datum tekening: 07/07/2021	■ Formaat: ISO full bleed A2 (594.00 x 420.00 MM)	■ Schaal: 1:20
---------------------------	--------------------------	--------------------	---------------------------------	---	-------------------

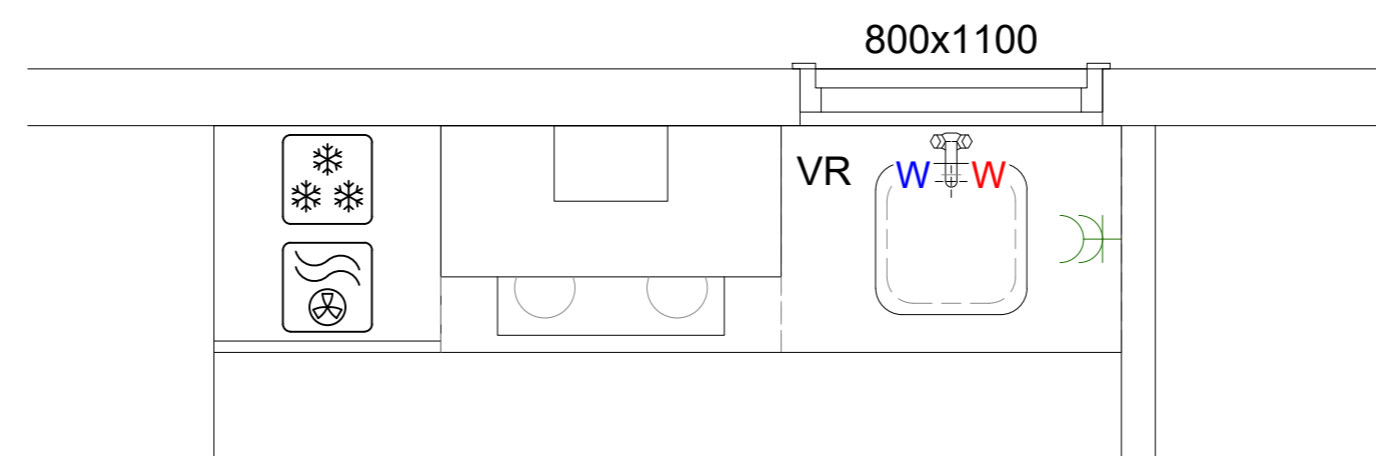
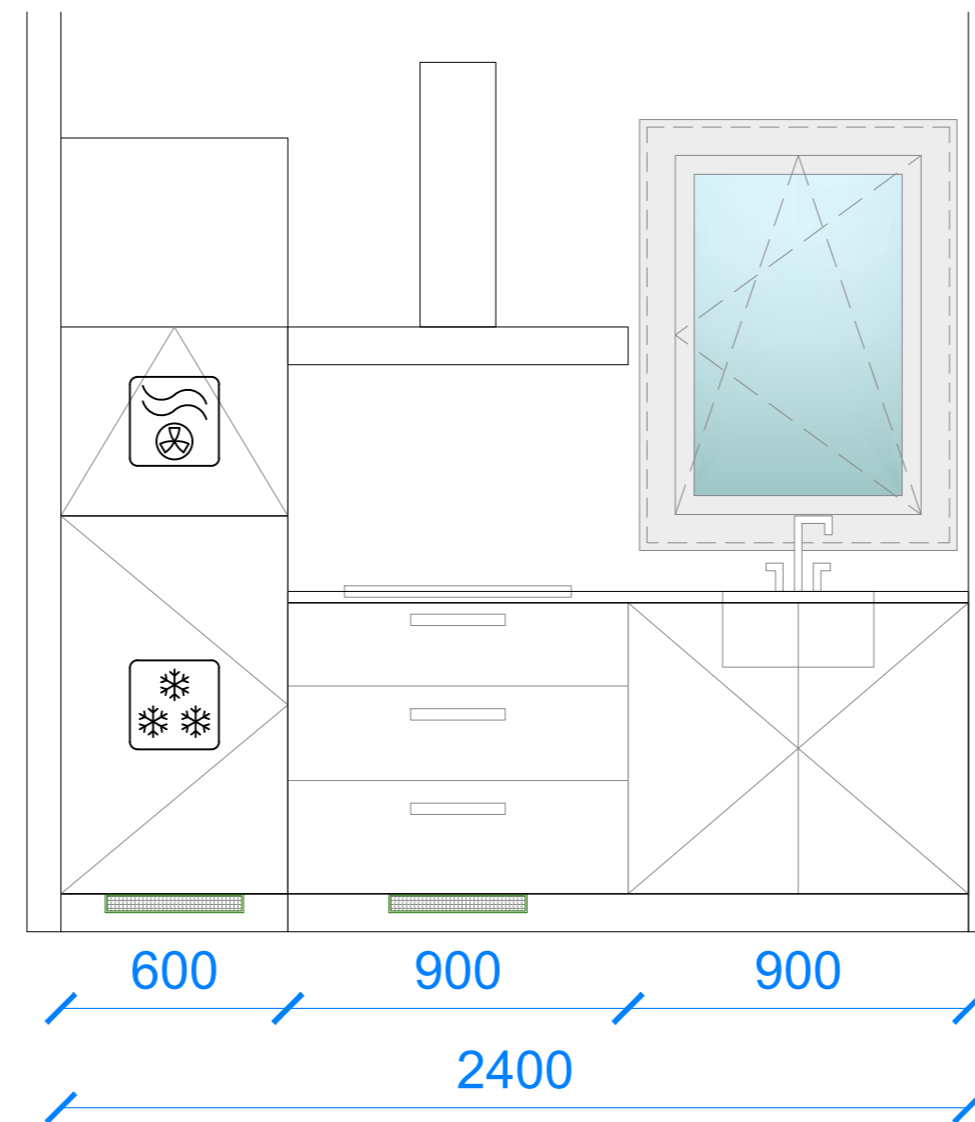

#### Keuken:

- o Keuken opstelling Recht.
- o Inbouw ETNA apparatuur.
- o RVS afzuigschouw 90cm.
- o Inductie kookplaat 60cm.
- o Inbouw combi magnetron.
- o Inbouw koelkast met vriesvak.
- o Front kleur Marieke Zandgrijs 200
- o Werkblad kleur Carmin Mozaïek MK 432
- o Greep: Stanggreep RVS 128mm 0948
- o Werkblad hoogte: Standaard 95cm hoog.
- o Spatrand 25 cm hoog in kleur van werkblad.
- o Gootsteenbak 35 x 45cm RVS met korfplug.
- o Kraan: type Grohe Mengkraan.

Projectnaam:	Projectnummer:	Type:	Datum tekening:	Formaat:	Schaal:
Sessink	4573	Anemoon	07/07/2021	ISO full bleed A2 (594.00 x 420.00 MM)	1:20



2690

2140

A

Binnenkant kozijn

Dagmaat 2650x2100mm

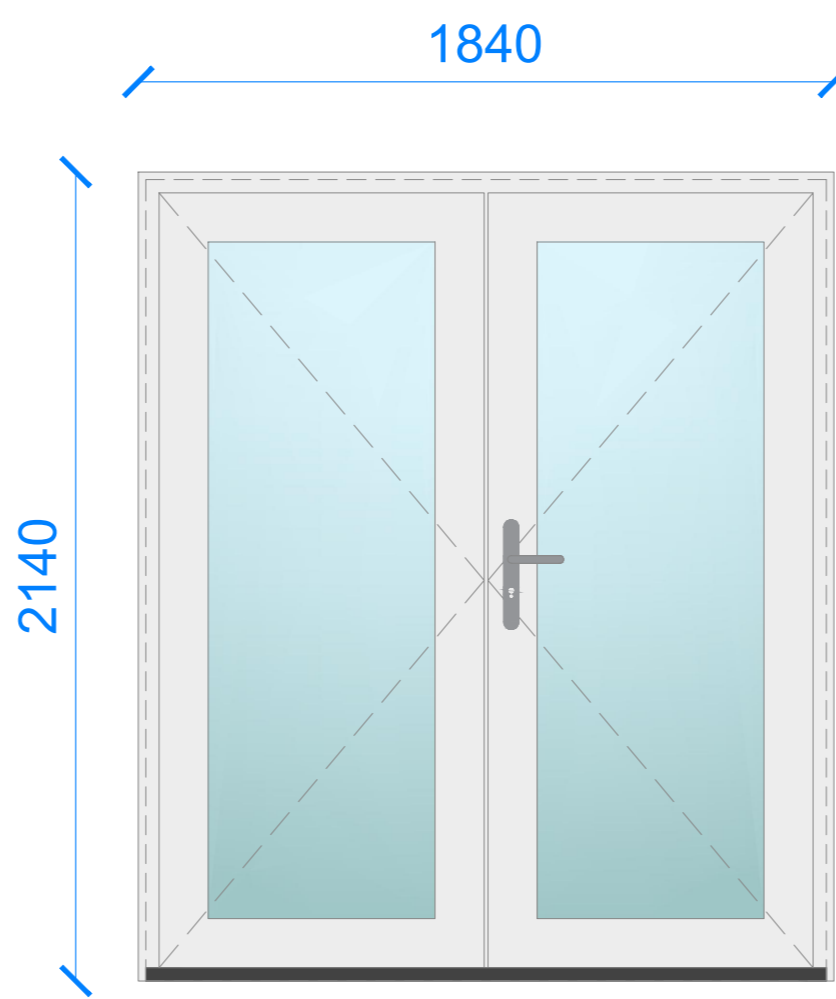

1840

2140

B

Dagmaat 1800x2100mm

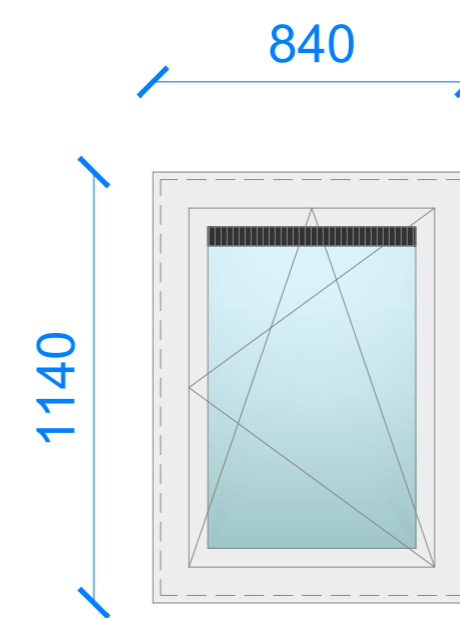

840

1140

C

Dagmaat 800x1100mm

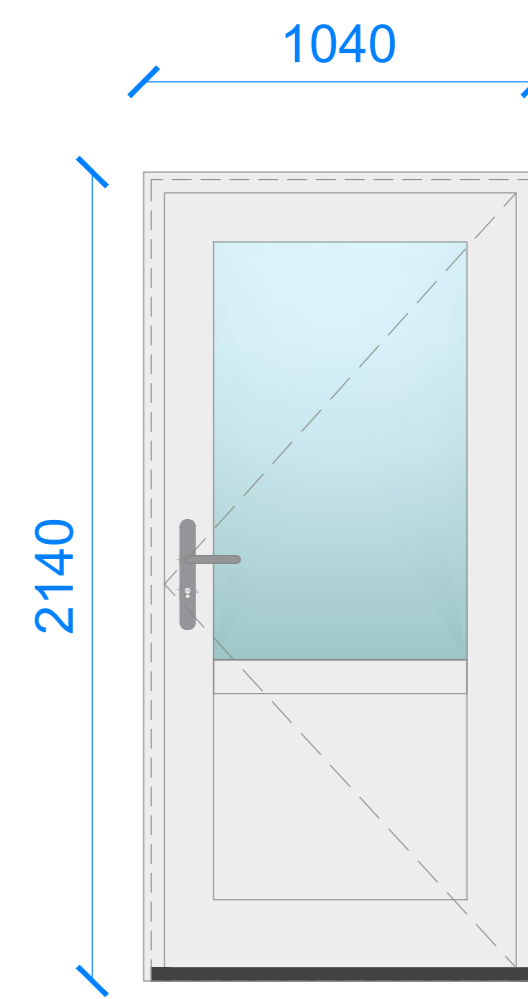

1040

2140

D

Dagmaat 1000x2100mm

VR

Buitenkant kozijn

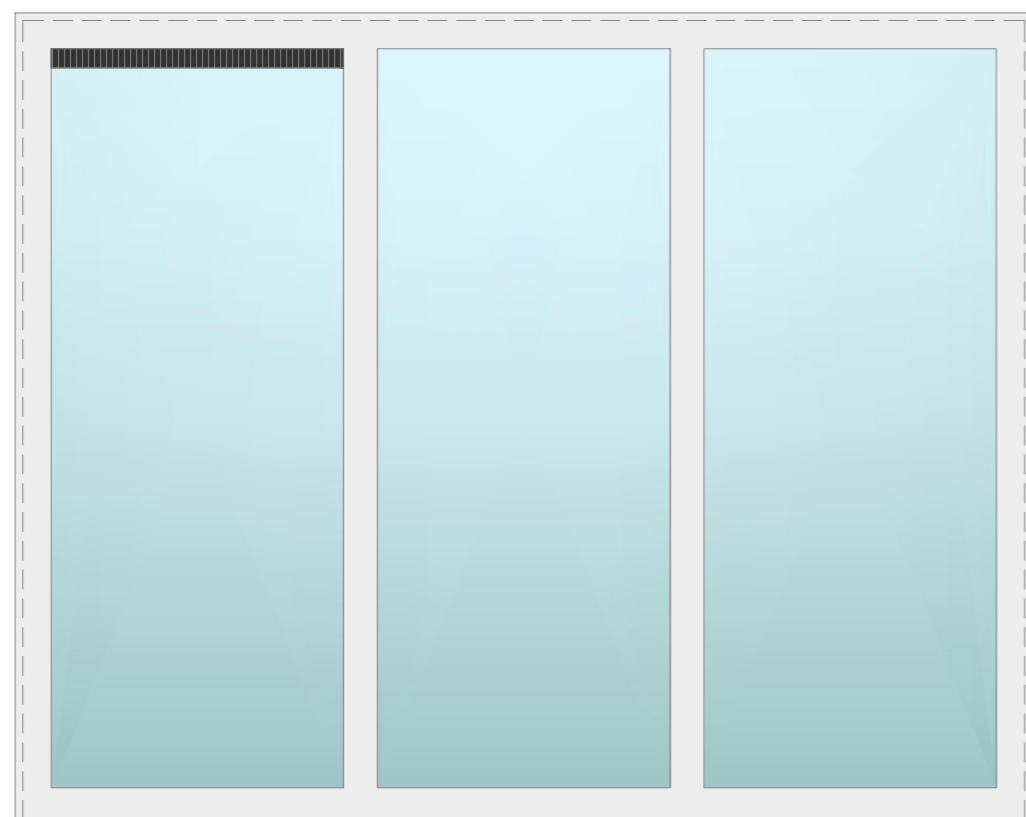

VR

HOR

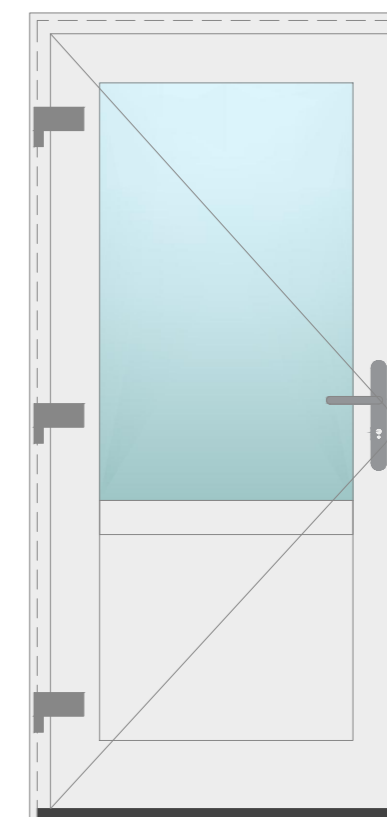
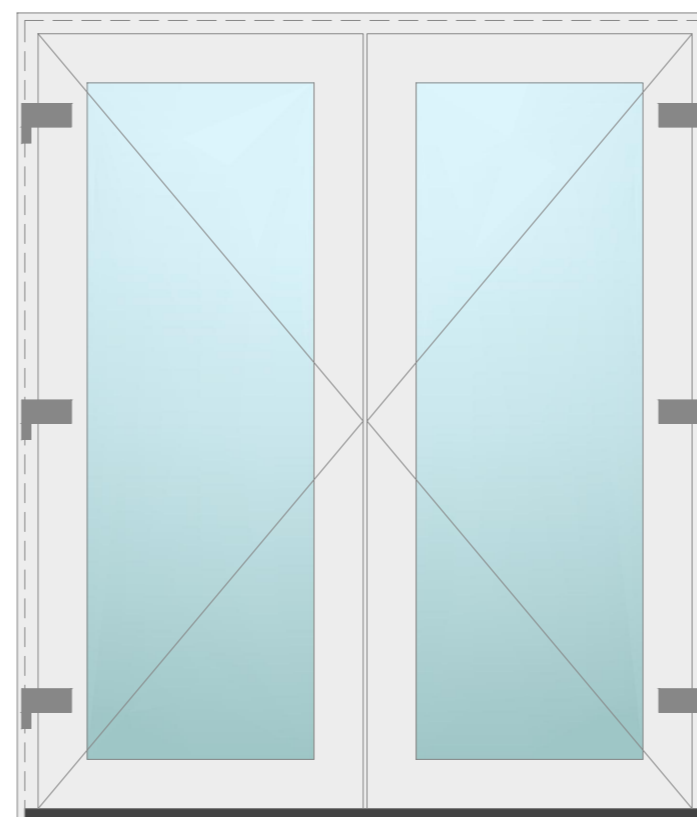
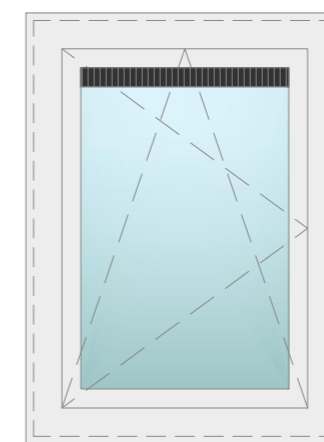

- Kunststof buitenkozijnen.
- o Profiel : Verdiept
- o Kleur Buiten : Wit Glad.
- o Kleur Binnen : Wit Glad.
- HR ++ dubbel isolatie glas.
- Ventilatie roosters waar aangegeven.
- Matglas in badkamer.
- Aluminium hoeklijn 40 x 60mm onder alle kozijndorpels.
- Alle kozijnen met een draaideur voorzien van een lage dorpel

Projectnaam: Sessink	Projectnummer: 4573	Type: Anemoon	Datum tekening: 07/07/2021	Formaat: ISO full bleed A2 (594.00 x 420.00 MM)	Schaal: 1:20
-------------------------	------------------------	------------------	-------------------------------	---	-----------------



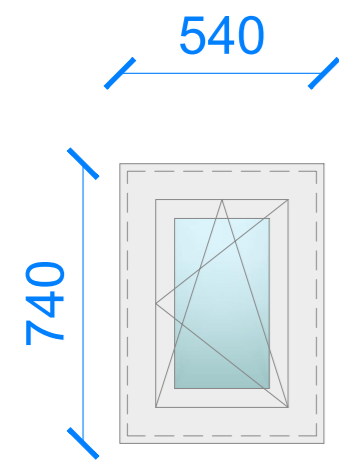

540

740

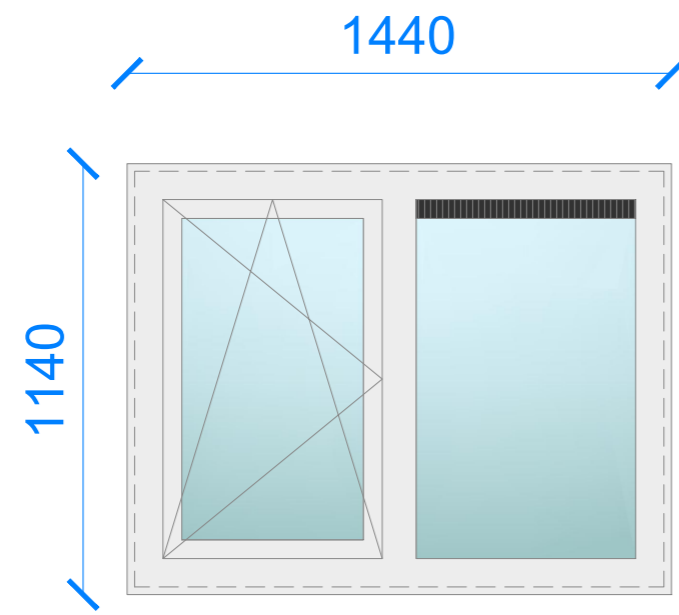

1440

1140

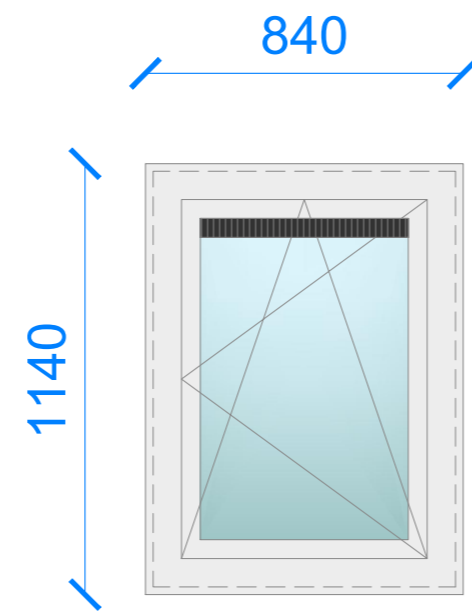

840

1140

E

Dagmaat 500x700mm

F

Dagmaat 1400x1100mm

G

Dagmaat 800x1100mm

Matglas  
HOR

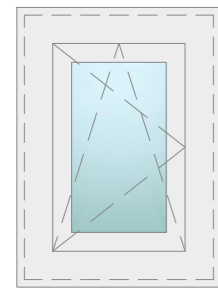

VR  
HOR

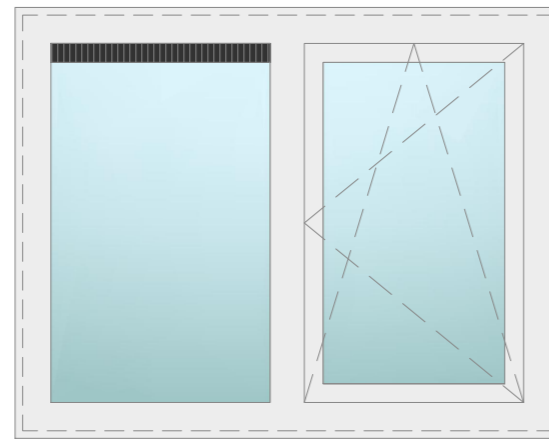

VR  
HOR

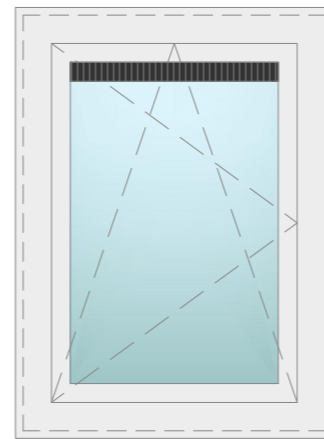

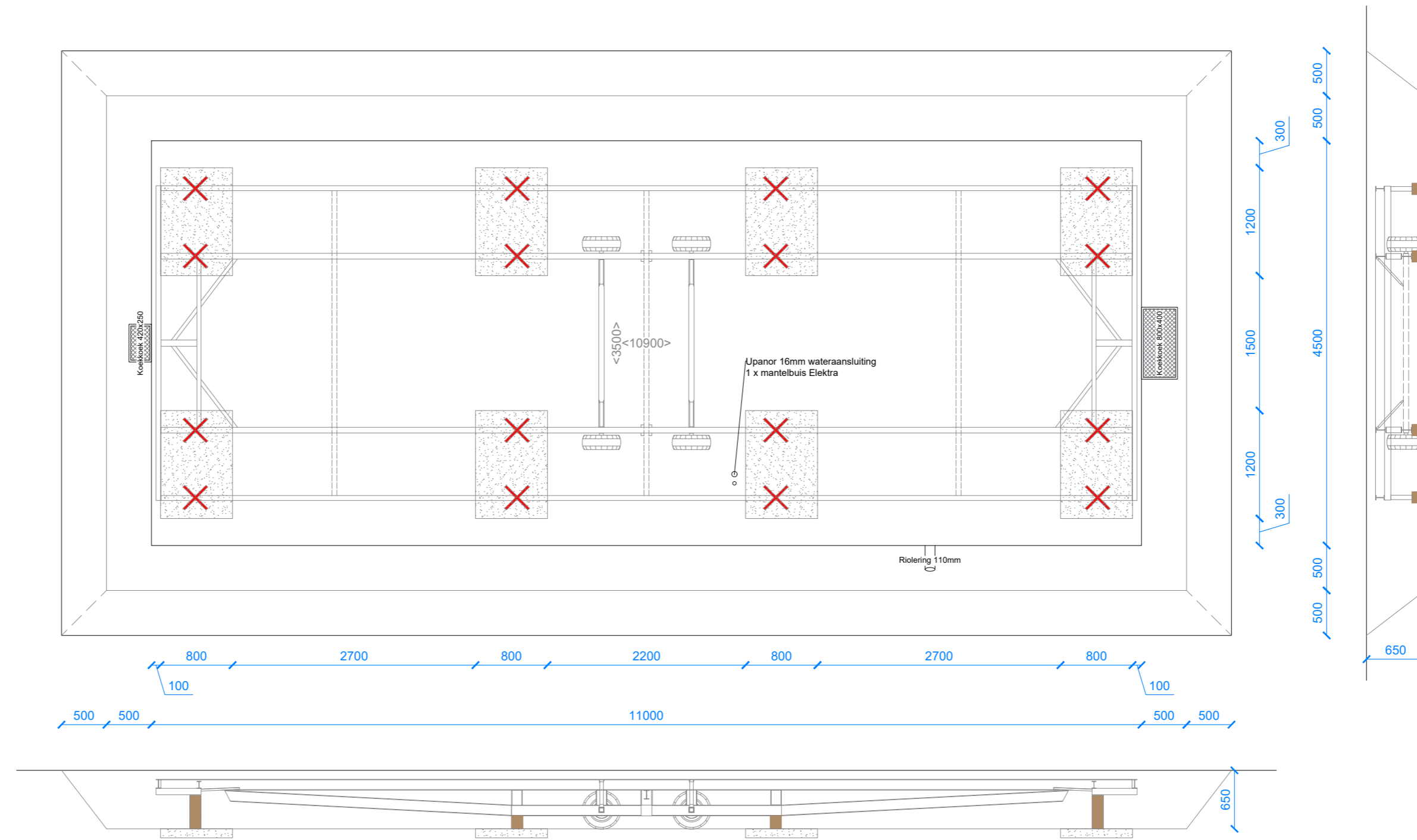

■ LET OP!

Bouwput 65cm uitgraven, tenzij anders aangegeven op tekening
Onder de betonplaten een verdichte grond/zandlaag aanbrengen van Ca. 30cm
Indien er geplaatst wordt met een trekker, de zandlaag rondom de platen verhogen en verdichten tot bovenkant van de betonplaat

Type:	Versie: 1	Formaat: A3	Projectnummer:
Anemoon	Schaal: 1:50		4573
Projectnaam:	Datum aangepast: 07/07/21		
Sessink			